

version .0

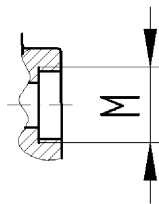
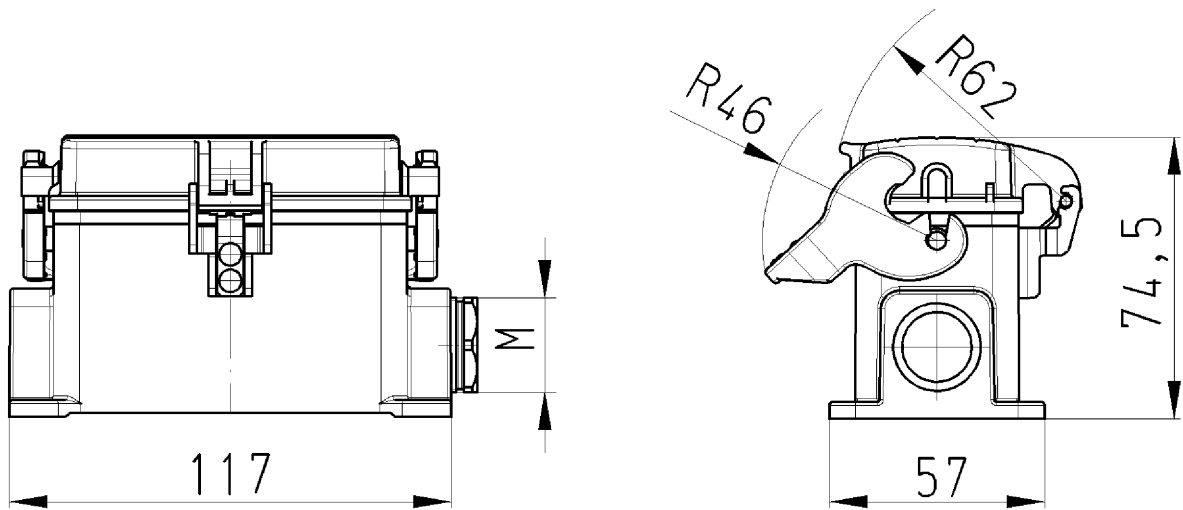

version .1

Gehäuseunterteil
71.341.1635.0

Zeichnungsnummer
71.341.1635.010W
Gehäuseunterteil

12.12.2007
Hoffmann Angelika
M 1:2